



straumann



Fodder mixing wagons

Verti-Mix 40/50/70

Verti-Mix

Verti-Mix-L

Verti-Mix Double

Verti-Mix Double K

Verti-Mix Triple



Verti-Mix

- One for all

Strautmann foddermixing wagons

Strautmann foddermixing wagons

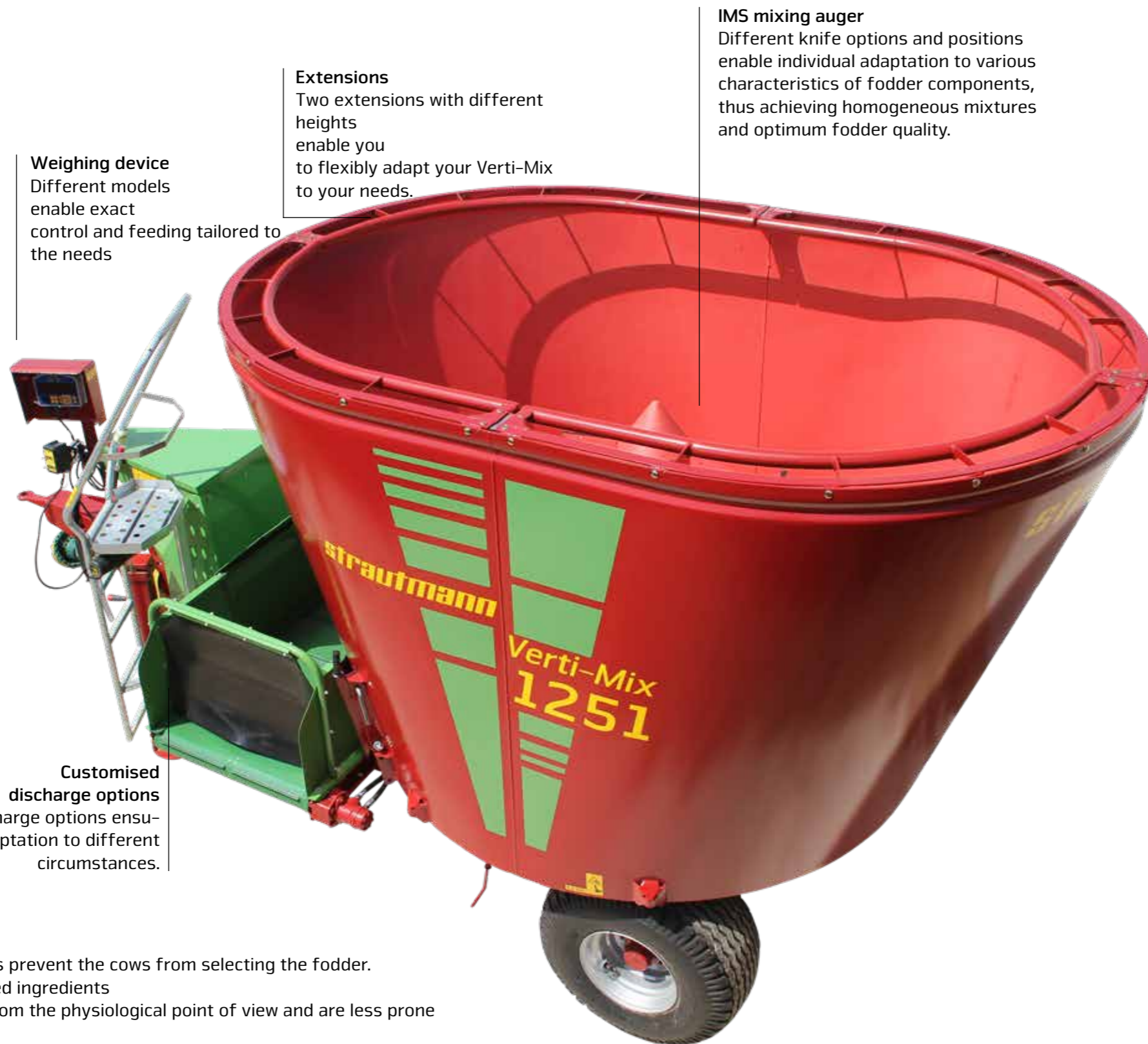

Drawbar
Narrow and thus easy to manoeuvre.
Easy to unscrew and reposition for change from bottom to top linkage and height adjustment.

Weighing device
Different models enable exact control and feeding tailored to the needs

Extensions
Two extensions with different heights enable you to flexibly adapt your Verti-Mix to your needs.

IMS mixing auger
Different knife options and positions enable individual adaptation to various characteristics of fodder components, thus achieving homogeneous mixtures and optimum fodder quality.

Customised discharge options
Most varied discharge options ensure individual adaptation to different circumstances.

Why mix fodder?

- Homogeneously mixed ingredients prevent the cows from selecting the fodder.
 - Higher milk yields with improved ingredients
 - All animals are optimally fed from the physiological point of view and are less prone to diseases
 - Healthy, long-living cows for a high degree of cost effectiveness
- Time saving and easier working
- Check of feed rations by means of weighing technology packages available as optional extras
- Possible addition of low-cost industrial by-products

Verti-Mix

What you are going to appreciate ...

- 1. Mixing quality**
...because only cows enjoying optimum nutrition are healthy and deliver a good milk yield!
- 2. Easy towing**
...because your diesel consumption is reduced!
- 3. Efficiency/Speed**
...because you quickly achieve a homogeneous mixture!
- 4. Flexibility**
...because machines should adapt to your enterprise!
- 5. Reliability**
..... because your cows must be fed on 365 days a year!

Be among those who benefit from our more than 30 years of experience in fodder mixing technology and become one of our approx. 20,000 reference businesses!

Contents

IMS mixing auger	4-5
Extend service life!	6
Equipment options	7
Verti-Mix 40/50/70	8-9
Verti-Mix Double K	10-11
Extensions	12-13
Verti-Mix	14
Verti-Mix-L	15
Verti-Mix Double	16
Verti-Mix Triple	17
Discharge options	18-21
Bedding	22-23
Weighing and operation	24-25
Technical data	26-31

IMS (Intensive Mix System) mixing auger – The allround talent

The IMS mixing auger

Variability and strength for any purpose

Due to the patented knife adjustment system, the IMS mixing auger can be perfectly adapted to your specific conditions of use. The robust and low-maintenance angular gear ensures long service life even under challenging conditions.

Strautmann Verti-Mix fodder mixing wagons substantially contribute to increase the productivity of modern dairy farms. The perfect geometry of container and IMS mixing auger is supported by the newly developed mixing auger. This ensures:

- Low power requirement
- Preservation of fodder structure
- Homogeneous mixing
- Energy-saving short mixing times

Excellent mixing quality and proven easy towing guarantee absolute cost-effectiveness for any kind of application.

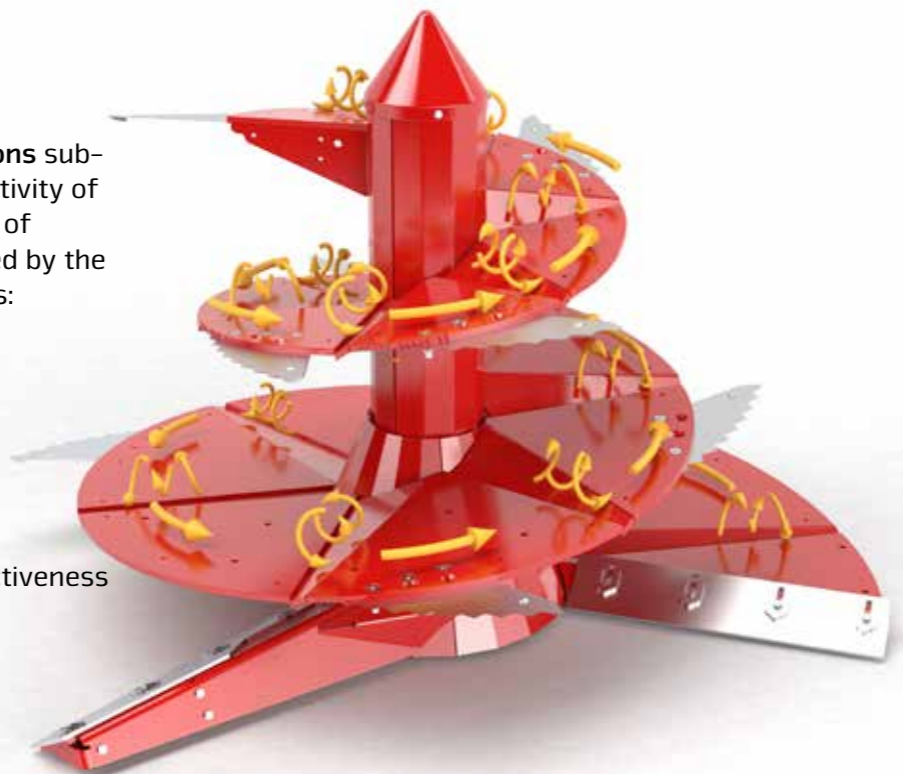

Adjustable front auger end/Scraper

Due to adjustable scraper bars at the front auger end and at the scraper, even finest components are reliably picked up from the ground and homogeneously mixed.



Robust heart

The heart of the IMS mixing auger is the very robust and durable gearbox. Stability and long maintenance intervals are achieved by means of a large-sized pair of tapered rollers, double sealing and a large grease chamber.



Effective mixing

The perfect harmonisation of mixing auger geometry and the distance to the container wall forms the basis for quick and homogeneous mixing.

Special equipment options help you to adapt your IMS mixing auger even better to your individual needs:



- Standard short knives
- Optional long knives, ideal for loosening straw and baled silage

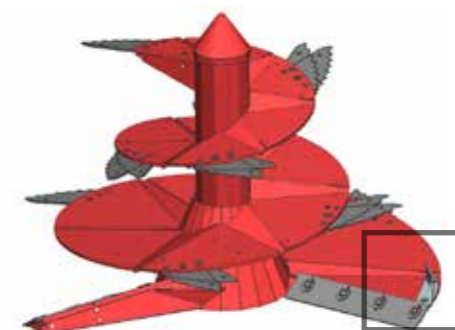

Scraper

„Scrapers“ especially developed for very poorly structured feed rations (compact TMR) ensure an additional mixing effect and an improved fodder movement.

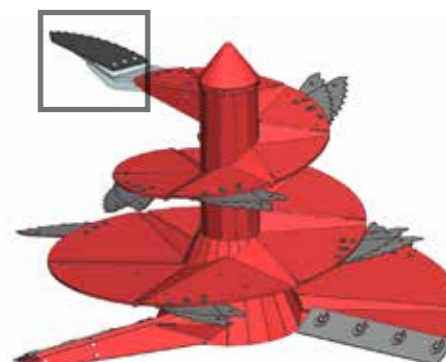

Bale knife

The **bale knife** is perfectly suitable for cutting round bales.

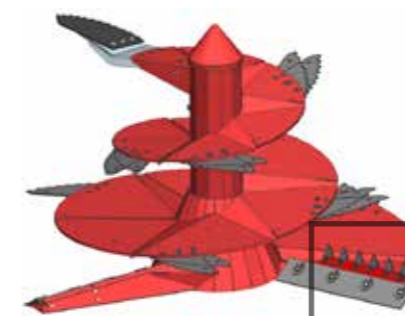

Root crop knife

For fodder rations containing e.g. beets or potatoes, the optionally available **root crop knife** ensures better mixing and additional crushing of the ingredients.

Magnetic system

Each silage and any kind of purchased fodder might contain metallic foreign objects which might harm your dairy cattle. The **Strautmann magnetic system** (optional) mounted directly at the mixing auger protects your valuable livestock against internal injuries, thus ensuring herd health. The industrial magnets are mounted such that they have direct and immediate contact with the mixed fodder and thus very effectively filter out metallic foreign objects without them being carried away again from the magnet by the following fodder.



Result after 14 days of using our magnets (wedding ring as reference in the bottom right of the photo)

Extend service life – Save money!

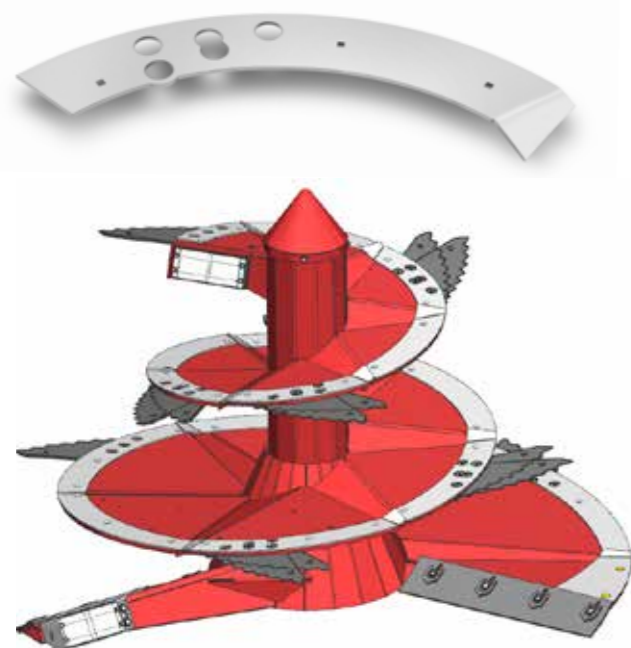

Innodur

Optional "INNODUR" wearing elements significantly extend the service life of the IMS mixing augers.

- 5 mm thick and 100 mm wide stainless steel elements
- Screwed to the auger windings with an overlap
- Quick and easy subsequent mounting also possible
- No labour-intensive welding required

Stainless steel lining

Fodder rations with a high maize percentage (>75 % of the dry substance content of the total ration), in particular have an increased percentage of aggressive lactic acid. The acid attacks the container material and promotes the formation of rust films. A stainless steel lining for the container effectively prevents this.



- Stainless steel elements
- 1.5 mm thick and 90 cm high side panel elements
- 3 mm thick bottom plate
- Also subsequently available with 3 mm thick side panel elements

For high demands – Heavy-duty design

When the mixing auger is replaced with a residual thickness of 5 mm:

Standard mixing auger 15 mm

- Wear material 10 mm

Heavy-duty mixing auger 20 mm

- Wear material 15 mm

→ 50% longer service life = 50 % less wear costs

Individual equipment options



Protective cover

between mixing auger and coaxial gearbox

- Made of robust plastic
- Recommended for compact mixtures (compact TMR) or for addition of larger quantities of water
- Reliable protection against fodder deposits between mixing auger and gearbox
→ Prevents the formation of toxic substances



Drawbar lug 40 mm



Rear-view camera & headlights



Monitor for rear-view camera



Coupling head linkage K80



Mineral feed funnel



Lighting



Counter-cutter (mechanical adjustment)



Counter-cutter (hydraulic adjustment)



Hydraulic motors – depending on the application, you can select from a range of motors of different speeds.

Verti-Mix 40/50/70

– best mixing with up to 7 m³

The three smallest models of the towed fodder mixing wagons, Verti-Mix 40/50/70, guarantee highest fodder quality and mixing accuracy – even for smaller rations. With a mixing capacity of up to 7 m³, up to 50 dairy cows can be fed once a day.

Optional weighing device
for exact dosing of all fodder components

IMS mixing auger
for a homogeneous feed ration

Optional extension
for increase of volume

Side discharge
selectable for the left-hand and/or right-hand side



Single discharge

- Feeding via side discharge options
- Selectable for the left-hand and/or right-hand side
- Loose and homogeneous fodder swathe
- The eccentric position of the discharge openings ensures even and quick fodder discharge.

Ladder

- Simplifies the addition of further components such as mineral feed or similar
- Galvanised for long service life
- Folding on Verti-Mix 40/50

Drawbar

- Available with top or bottom hitch
- Easy height adjustment by means of hole pattern

Verti-Mix 40/50/70

Verti-Mix 40/50/70



Technical data	Verti-Mix 40	Verti-Mix 50	Verti-Mix 70
Dimensions			
Length [m]	3.62	3.62	4.20
Width with one-sided discharge [m]	1.79	1.79	2.06
Width with two-sided discharge [m]	1.88	1.88	2.16
Height [m]	1.92 (2.07 with 150 mm extension)	2.18 (2.33 with 150 mm extension)	2.12 (2.37 with 250 mm extension)
Container wall thickness [mm]	6	6	6
Thickness of bottom plate [mm]	12	12	15
Dead weight			
Dead weight, basic machine [kg]	1,600	1,600	2,300
Loading capacity			
Loading capacity without extension [m ³]	4	5	6
Loading capacity with 150 mm extension [m ³]	4.5	5.5	-
Loading capacity with 250 mm extension [m ³]	-	-	7

Technical modifications reserved

Verti-Mix Double K

– low filling height with up to 21 m³

Low stable overhead clearances or limited charging ranges are no longer a problem with the Verti-Mix Double K. The conical shape of the patented container enables a position of the tyres next to the container. Thus, the filling height remains low – even with large tyres and a mixing capacity of up to 21 m³.



Verti-Mix Double K

Optional weighing device for exact dosing of all fodder components

2 IMS mixing auger for a homogeneous feed ration



Patented container shape for a compact design with a large mixing capacity and large-sized 22.5" tyres

Conical container shape

- Patented shape: Conical container, in the rear section equipped with a smaller mixing auger
- More fodder swirling due to mixing augers of different size
 - More intensive mixing effect
- More fodder movement between the front and rear mixing auger
 - Reduced mixing times
- Enables the positioning of the wheels next to the container without affecting the vehicle width
- Large tyres possible for excellent running characteristics

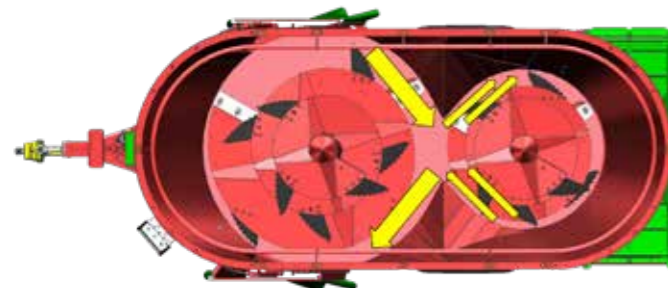

Various discharge options

Most varied discharge options (side discharge options, crossover conveyor belts) enable a perfect adaptation of the machine to operational circumstances.



Technical modifications reserved

Verti-Mix Double K

	Verti-Mix 1300 Double K with 315/80 R 22.5 tyres	Verti-Mix 1500 Double K with 315/80 R 22.5 tyres	Verti-Mix 1800 Double K with 385/65 R 22.5 tyres	Verti-Mix 2100 Double K with 385/65 R 22.5 tyres
--	--	--	--	--

Technical data

Dimensions				
Length [m]	5.80	5.87	6.28	6.36
Height [m]	2.36	2.58	2.61	2.86
Width with crossover conveyor [m]	2.16	2.16	2.42	2.42
Width with one-sided discharge [m]	2.28	2.28	2.54	2.54
Width with two-sided discharge [m]	2.38	2.38	2.64	2.64
Outside wheel width [m]	2.17	2.17	2.45	2.45
Length with rear crossover conveyor [m]	5.97	5.97	6.41	6.41
Container ground clearance [m]	0.57	0.57	0.57	0.57
Distance Centre of drawbar lug - Centre of axle [m]	3.96	3.96	4.27	4.27
Dead weight				
Basic machine from [kg]	4,900	5,400	6,200	6,700
Gross vehicle weight rating				
Admissible tongue load [kg]	1,800	1,800	2,000	2,000
Technically admissible gross vehicle weight rating 15 km/h, single axle [kg]	13,800	13,800	16,000	16,000
Gross vehicle weight rating 25 km/h (StVZO), single axle [kg]	11,800	11,800	12,000	12,000
Power required				
without switchgear [kW/HP]	51/70	64/84	72/99	79/108
with switchgear [kW/HP]	36/50	39/54	44/61	48/66
Loading capacity				
Usable mixing capacity* [m ³]	13.0	15.0	18.0	21.0
Axle				
Track width [mm]	1,850	1,850	2,060	2,060
Container				
Container wall thickness [mm]	8	8	8	8
Bottom plate [mm]	20	20	20	20
Container length inner dimension incl. overflow ring [m]	4.28	4.42	4.83	4.99

* Actually usable mixing capacity, augers having been deducted from the capacity

Technical modifications reserved

Verti-Mix

– The one-auger mixer with up to 16.5 m³

The **Verti-Mix** is the compact classic model of the Strautmann vertical mixers. The innovative extension concept enables expanding enterprises to adapt these fodder mixing wagons to their current requirements. The IMS mixing auger in stepped flight design and the individual discharge options make the Verti-Mix an all-rounder.



Technical modifications reserved

Verti-Mix-L

– Homogeneous mixing, flat bed – up to 12.5 m³

The **Verti-Mix-L** with the intelligently positioned axle is particularly suitable for low stable overhead clearances. Depending on the tyres and the extension, a very low height of 2.11 m can be implemented. Thus, even charging a vehicle of limited height is no problem.



Technical modifications reserved

Verti-Mix Double

– Twice as good with up to 31 m³

The fodder mixing wagons of the **Verti-Mix Double** series particularly excel by their high mixing capacity, while maintaining compact dimensions. The innovative extension concept enables expanding enterprises to adapt these fodder mixing wagons to their current requirements.

Patented extension concept with 2 extension options

2 IMS mixing auger for a homogeneous feed ration



Customised discharge options for homogeneous fodder discharge

Optional with tandem axle



Smart container

- The adapted container geometry enables ideal vertical and horizontal mixing
→ Shorter mixing times
- Standard overflow ring for additional stability
→ Prevents the fodder from overflowing

Power train

- Drive of 2nd mixing auger via an additional T-coaxial gearbox
- One shear bolt coupling in front of each mixing auger gear
- Optionally equipped with 2-level reduction gear

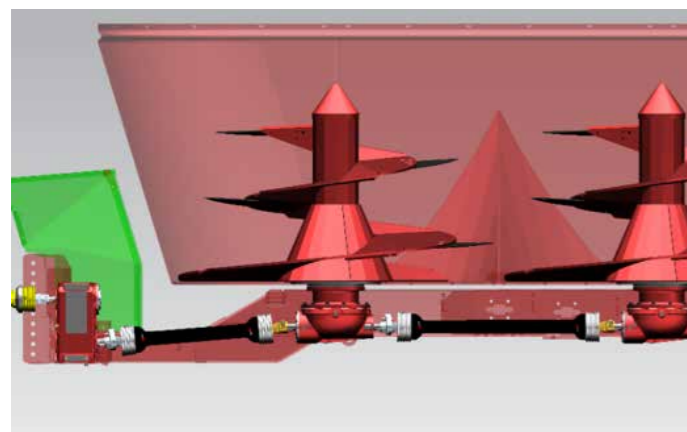

Technical modifications reserved

Verti-Mix Triple

– 3 mixing augers for a maximum of 45 m³

The **Verti-Mix Triple** mixes large volumes in a homogeneous and efficient way. The Strautmann container geometry enables ideal mixing with little power and time required. Feed up to 270 cows with one mixture!

Patented extension concept with 2 extension options

Special container geometry for perfect vertical and horizontal mixing



Optional power shift gearbox



Chassis

Verti-Mix 3451 Triple:

- Standard rigid tandem axle
- Options:
- Tandem axle with passive steering
 - Tandem axle with forced steering axle system
 - Tridem axle with passive steering
 - Tridem axle with forced steering axle system

Verti-Mix 4501 Triple

- Standard tridem axle with passive steering
- Option:
- Tridem axle with forced steering axle system

Forced steering axle system

- Mechanical-hydraulic forced steering axle system
- Simple, robust and safe in use
- Particularly easy to manoeuvre, enables comfortable reverse travel
- Minimised tyre wear

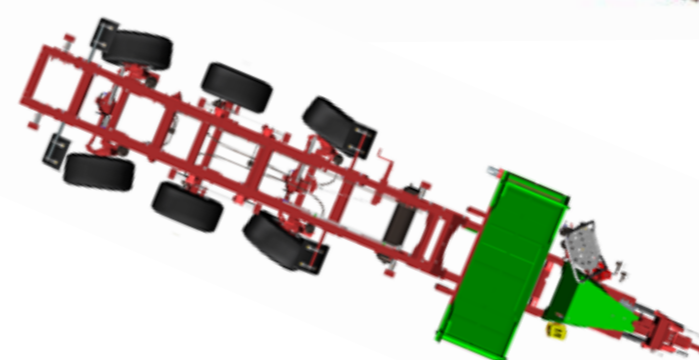

Power shift gearbox

- Optional 2-level or 3-level power shift gearbox
- Less power required compared to the mechanical switchgear due to the fact that switching under load is possible
- Equipped with standard continuous oil cooler
- Operation via E-control with integrated touch terminal



Technical modifications reserved

You want your business to grow –Your Verti-Mix adapts to your growing needs

The patented container embossing at the top container edge provides the Straumann mixing container with additional strength and stability. It serves as the basis for variable container extensions enabling you to adapt the capacity of the mixing container to your operational requirements.

Your advantages:

- Flexible customised extension of the capacity
- Highest stability of the container due to embossing
- Design of all components for maximum possible container capacity



Full use of container capacity. Depending on the space available in the enterprise, different extension options are at your disposal.

Inner overflow ring for optimum container use in case of low overhead clearances.

If extensions are added, continue to use the overflow ring.

Verti-Mix to Verti-Mix Triple

Verti-Mix to Verti-Mix Triple



The right Verti-Mix – For your needs...

Container width Container height*

2.16 m 2.30 m



2.28 m 2.61 m



2.42 m 2.76 m



2.42 m 2.94 m



1.96 m 2.28 m



2.16 m 2.34 m



2.28 m 2.68 m



2.42 m 3.12 m



2.28 m 2.78 m



2.42 m 3.08 m



- Feeding of 6–8 cows per m³ when feeding once a day (depending on the ingredients/TS content)
- Volume adjustment possible by means of container extensions
- Basic machine/Mixing auger is always designed for maximum capacity
- The volume specified corresponds to the actual mixing capacity. The mixing augers have already been deducted from the volume.

*with smallest tyres
Technical modifications reserved

Discharge options – adapted to your enterprise

Verti-Mix to Verti-Mix Triple



In the case of side discharge, the eccentric position of the discharge openings ensures **homogeneous fodder discharge**.

- Loose and homogeneous fodder swathe
- Discharge position at optimum location at the fodder mixing wagon, relative to the flow of material in the container
- No travelling over the fodder
- No fodder deposits at the gate

Select from a multitude of discharge options and make your fodder mixing wagon a specialist.

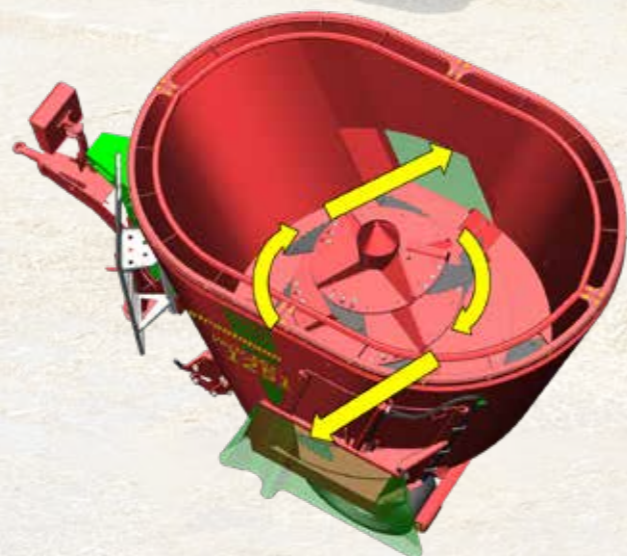

- Fodder-protecting discharge via adjustable side chutes**
- At the side discharge devices, adjustable chutes support the fodder discharge
The side chute mechanically operated by the side gate
- moves to rest position with the gate closed – Fodder residues move onto the swathe and do not fall onto the drive path
 - ensures fodder discharge beyond the lane – the wheels do not roll over the discharged fodder



- Discharge in narrow dead-end feeding passages**
- For comfortable feeding even in narrow dead-end feeding passages, side gates behind the wheels are used.
 - The fodder is loosely discharged on one or both sides behind the wheels.*



- Rear centre discharge***
- For central fodder discharge on the feeding table
 - Ideal for the dosing of premixtures in silo units



- Side discharge with conveyor extension***
- Discharge with hydraulically folding conveyor extension
 - Variable discharge width due to optional speed adjustment via hand-operated regulator or E-control
 - Enables dosing into elevated feeding troughs

*except for Verti-Mix 40/50/70

Technical modifications reserved

Verti-Mix to Verti-Mix Triple

Even and loose discharge – The Strautmann crossover conveyor

Easy discharge within the field of view. The Strautmann crossover conveyor proven in ten thousands of applications discharges the mixed feed (in case of front discharge) – due to the open design easily visible for the driver on the right-hand or left-hand side in the direction of motion. Variable conveyor speeds achieved by means of different motors or direct adjustability enable the fodder discharge width to be adapted as far as right up to directly in front of the feed fence. Speed adjustment is optionally available in mechanically-operated or electrically-operated version. The crossover conveyor drive is equipped with a standard floating oil motor, such that the conveyor is particularly smoothly running and there is no risk of bearing distortions. The crossover conveyor is directly connected with the container. Thus, fodder residues on the conveyor are also weighed and exact fodder discharge is ensured.

The proven lattice bar roller ensures high tractions of the driving roller and slip-free power transmission. It prevents material from piling up on the roller and increases the service life of the conveyor thanks to the gentle return of the conveyor.

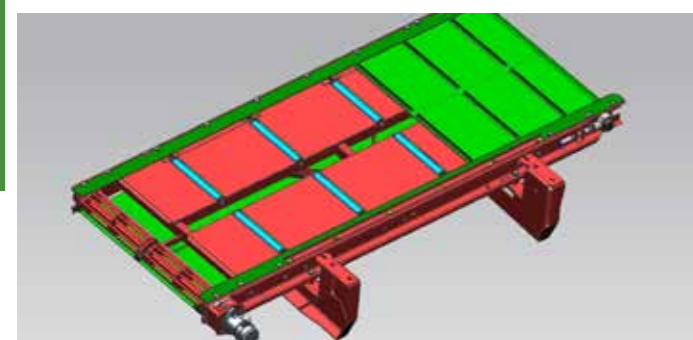

Front crossover conveyor

- Clean and homogeneous fodder discharge
- Optimum view of the fodder discharge from the tractor seat
- Variable discharge width due to optional speed adjustment via hand-operated regulator or E-control
- Optional 2nd hydraulic motor for two-sided drive



Rear crossover conveyor

- Clean and homogeneous fodder discharge
- Ideal for discharge in dead-end feeding passages
- Optimum view to the rear due to optional rear-view camera
- Variable discharge width due to optional speed adjustment via hand-operated regulator or E-control



Front V-conveyor

- Conveyor with displacement to the side (25 cm on both sides) and height adjustment (0-55 cm)
- Equipped with 2 standard hydraulic motors
- For most varied stable conditions
- Discharge at a distance to the machine or into elevated troughs



Crossover conveyor with hydraulically folding conveyor extension

- Clean and homogeneous fodder discharge
- Enables the charging of elevated troughs and feeding tables
- Despite increased discharge width, compact dimensions due to hydraulic swivel mechanism
- Variable discharge width due to optional speed adjustment via hand-operated regulator or E-control



Dual-use machine

- Cubicle management with your Verti-Mix



Verti-Mix to Verti-Mix Triple

Additional benefit for your Verti-Mix by use as bedding equipment

A high-yield cow requires 2 kg of bedding material every day – more than 6 t per month for 100 cows. Thanks to this optional extra equipment, your Verti-Mix fodder mixing wagon can also be used for that type of work.



Fast bedding roller*

The cleaner and more germ-free the cubicle, the healthier the animals. The ideal bedding materials are straw, peat, sawdust and lime. After the mixing process in the container has been finished, the bedding material is spread up to the head region of the cubicles via the roller – comfortably and reliably for maximum animal comfort and udder health. If not in use, the roller can be easily folded to transport position by hydraulic operation.

*only in combination with E-control



In transport position

Technical modifications reserved



Verti-Mix, Verti-Mix Double



Straw blower*

- The IMS mixing auger easily cuts up the straw bale and undoes it.
- The mechanically powered straw blower throws the bedding mixture up to a width of 20 m into the stable.
- Electro-hydraulic operation for the straw blower functions
- The standard position of the blower outlet is on the right-hand side in the direction of motion.
- The throwing range can be hydraulically adjusted by means of a chute.



Feeding roll

Feeding roll

- Optional hydraulically powered feeding roll
- Positioning in front of the throwing blower enables interruption of the discharge by switching the roll off
- Particularly recommended for more humid bedding mixtures and fodder discharge into elevated troughs



Rotary tower adjustment

- Optional rotary tower adjustment
- Throwing blower can be hydraulically rotated from the right-hand discharge in the direction of motion to left-hand discharge

*not available on Verti-Mix 40/50/70, Verti-Mix-L, Verti-Mix Double K, Verti-Mix Triple
(Straw blower only available with front discharge)

Technical modifications reserved

Operating and weighing

- Take your choice

The Strautmann operating options

Strautmann responds to individual customer demands also with regard to the kind of operating device. The selection of the operating option depends on the user's requirements.



1. Direct tractor connection

Precondition:
One double-acting control device for each function

Reasonable if:
... the tractor is uncoupled only rarely
... the fodder mixing wagon is only equipped with a side discharge



2. Operation via Bowden cable

Precondition:
One double-acting control device at the tractor or alternatively one single-acting control device with free return line

Reasonable if:
... older tractors with only a few control devices are used



3. Electrical control set

Precondition:
One double-acting control device at the tractor or alternatively one single-acting control device with free return line

Reasonable if:
... awareness of comfort is existent and an increase in efficiency is requested
... the number of existing control devices is not sufficient for the machine functions



Weighing devices

The weighing device is an integral component of the fodder mixing wagon. Only an exact quantity determination of the individual ingredients ensures full use of the profitability of the fodder mixing wagon.



PTM AV 70
Radio remote control

1. PTM HL 50 -programmable weighing device

The PTM HL 50 is the start model of the Strautmann weighing devices

- 50 recipes
- From 30 ingredients
- Assessment
- Acoustic/Visual signal
- Compatible with radio remote control AV 70 for comfortable operation of weighing computer from the charging vehicle

2. PTM Advance Super USB - programmable weighing device with optional data transfer

A complete feeding control including time recording is of fundamental importance for cost optimisation on dairy farms.

- 150 recipes
- From 30 ingredients
- Multiline display
- Multi-Link compatible - several devices can be connected
- Optional: Read-out and management by means of included software
- Optional: Wireless communication with farm PC via WLAN antenna
- Compatible with radio remote control AV 70 for comfortable operation of weighing computer from the charging vehicle

Technical data

	Verti-Mix 951-L 7.5 / 8.5 / 9.5 [m³]	Verti-Mix 1251-L 10.0 / 11.0 / 12.5 [m³]
Dimensions		
Length [m]	4.85	4.98
Width with one-sided discharge [m]	2.26	2.38
Width with two-sided discharge [m]	2.36	2.48
Outside wheel width [m]	1.90	1.90
Discharge height [m]	0.54	0.54
Distance Centre of drawbar lug - Centre of axle [m]	4.48	4.48
Dead weight		
Basic machine [kg]	3,150 / 3,200 / 3,250	3,700 / 3,800 / 3,900
Gross vehicle weight rating		
Admissible tongue load [kg]	2,500	2,500
Technically admissible gross vehicle weight rating 15 km/h, single axle [kg]	8,700	8,700
Power required HP		
without switchgear 26 rpm	35 / 39 / 42	50 / 53 / 56
with switchgear 14.4/26 rpm	25 / 28 / 30	35 / 38 / 41
without switchgear 30 rpm	44 / 47 / 51	67 / 70 / 73
with switchgear 16.7/30 rpm	32 / 34 / 37	47 / 50 / 53
Power required kW		
without switchgear 26 rpm	26 / 29 / 31	37 / 39 / 41
with switchgear 14.4/26 rpm	18 / 21 / 22	26 / 28 / 30
without switchgear 30 rpm	32 / 35 / 38	49 / 51 / 54
with switchgear 16.7/30 rpm	24 / 25 / 27	35 / 37 / 39
Axle		
Track width [mm]	1,650	1,650
Container		
Container wall thickness [mm]	8	8
Bottom plate [mm]	18	20
Container length inner dimension incl. overflow ring [m]	2.63	2.93
Vehicle height depending on tyres with single axle		
30 x 11.5 - 14.5 [m]	2.11 / 2.35 / 2.53	2.40 / 2.58 / 2.76
250-15 18 (18 PR) [m]	2.12 / 2.30 / 2.48	2.40 / 2.58 / 2.76
10.0/75-15.3 (18 PR) [m]	2.18 / 2.36 / 2.54	-
400/60-15.5 (18 PR) [m]	2.17 / 2.35 / 2.53	2.46 / 2.64 / 2.82



Technical modifications reserved

	Verti-Mix 951 7.5 / 8.5 / 9.5 [m³]	Verti-Mix 1251 10.0 / 11.0 / 12.5 [m³]	Verti-Mix 1401 12.0 / 13.0 / 14.0 [m³]	Verti-Mix 1651 13.5 / 15.0 / 16.5 [m³]
--	--	--	--	--

Dimensions				
Length [m]	4.65	4.87	5.10	5.10
Width with crossover conveyor [m]	2.16	2.28	2.42	2.42
Width with one-sided discharge [m]	2.26	2.38	2.52	2.52
Width with two-sided discharge [m]	2.36	2.48	2.62	2.62
Outside wheel width [m]	1.78	2.04	2.23	2.23
Extension height [m]	- / 0.18 / 0.36	- / 0.18 / 0.36	- / 0.18 / 0.36	- / 0.18 / 0.36
Length with front crossover conveyor [m]	5.30	5.50	5.75	5.75
Length with rear crossover conveyor [m]	4.90	5.04	5.17	5.17
Discharge height, crossover conveyor [m]	0.75	0.87	0.74	0.74
Distance Centre of drawbar lug - Centre of axle [m]	3.38	3.47	3.72	3.72
Distance Centre of drawbar lug - Centre of axle with front crossover conveyor [m]	4.10	4.19	4.29	4.29
Dead weight				
with crossover conveyor [kg]	3,200 / 3,250 / 3,300	3,800 / 3,900 / 4,000	4,700 / 4,800 / 4,900	4,900 / 5,000 / 5,100
Gross vehicle weight rating				
Admissible tongue load [kg]	1,000	1,200	1,400	1,400
Technically admissible gross vehicle weight rating 15 km/h	7,000	12,000	12,200	12,200
Single axle [kg]				
Gross vehicle weight rating 25 km/h (StVZO)	7,000	9,000	11,400	11,400
Single axle [kg]				
Power required HP				
without switchgear 23 rpm	-	-	-	73 / 80 / 88
with switchgear 12.8/23 rpm	-	-	-	45 / 49 / 54
without switchgear 26 rpm	35 / 39 / 42	50 / 53 / 56	64 / 69 / 74	-
with switchgear 14.4/26 rpm	25 / 28 / 30	35 / 38 / 41	40 / 43 / 46	-
without switchgear 30 rpm	44 / 47 / 51	67 / 70 / 73	76 / 82 / 88	88 / 96 / 105
with switchgear 16.7/30 rpm	32 / 34 / 37	47 / 50 / 53	54 / 58 / 62	62 / 69 / 73
Power required kW				
without switchgear 23 rpm	-	-	-	54 / 59 / 65
with switchgear 12.8/23 rpm	-	-	-	33 / 36 / 40
without switchgear 26 rpm	26 / 29 / 31	37 / 39 / 41	47 / 51 / 54	-
with switchgear 14.4/26 rpm	18 / 21 / 22	26 / 28 / 30	29 / 32 / 34	-
without switchgear 30 rpm	32 / 35 / 38	49 / 51 / 54	56 / 60 / 65	65 / 71 / 77
with switchgear 16.7/30 rpm	24 / 25 / 27	35 / 37 / 39	40 / 43 / 46	46 / 51 / 54
Axle				
Track width [mm]	1,510	1,630	1,740	1,740
Container				
Container wall thickness [mm]	8	8	8	8
Bottom plate [mm]	18	20	20	20
Container length inner dimension incl. overflow ring [m]	2.63	2.93	3.27	3.27

Technical modifications reserved

Verti-Mix 951 7.5 / 8.5 / 9.5 [m³]
 Verti-Mix 1251 10.0 / 11.0 / 12.5 [m³]
 Verti-Mix 1401 12.0 / 13.0 / 14.0 [m³]
 Verti-Mix 1651 13.5 / 15.0 / 16.5 [m³]

Vehicle height depending on tyres with single axle	Verti-Mix 951	Verti-Mix 1251	Verti-Mix 1401	Verti-Mix 1651
30 x 11.5 - 14.5 [m]	2.30 / 2.48 / 2.66	2.59 / 2.77 / 2.95	-	-
250-15 18 (18 PR) [m]	2.32 / 2.50 / 2.68	2.61 / 2.79 / -	-	-
250-15 18 (18 PR) reduction of load capacity [kg]	-	8,500	-	-
10.0/75-15.3 (18 PR) [m]	2.31 / 2.49 / 2.67	-	-	-
400/60-15.5 (14 PR) [m]	2.43 / 2.61 / 2.79	-	-	-
400/60-15.5 (18 PR) [m]	-	2.72 / 2.90 / 3.08	2.89 / 3.07 / 3.25	3.05 / - / -
400/60-15.5 (18 PR) reduction of load capacity [kg]	-	-	9,660	9,660
8.15-15 (14 PR) double, track 1500 mm [m]	-	2.58 / 2.76 / 2.94	2.76 / 2.94 / 3.12	2.94 / 3.12 / 3.30
215/75R17.5 (133) double [m]	-	-	2.80 / 2.98 / 3.16	2.97 / 3.15 / 3.33
435/50 R 19.5 [m]	-	2.80 / 2.98 / 3.16	2.97 / 3.15 / 3.33	3.14 / 3.32 / 3.50

	Verti-Mix 1501 Double 12 / 13.5 / 15 [m³]	Verti-Mix 1801 Double 14 / 16 / 18 [m³]	Verti-Mix 2401 Double 19 / 21.5 / 24 [m³]	Verti-Mix 3101 Double 25 / 28 / 31 [m³]
Dimensions				
Length [m]	6.34	6.71	7.06	7.44
Width with crossover conveyor [m]	1.96	2.16	2.28	2.42
Width with one-sided discharge [m]	2.06	2.26	2.38	2.52
Width with two-sided discharge [m]	2.16	2.36	2.48	2.62
Outside wheel width [m]	2.03	2.03	2.25	2.37
Extension height [m]	- / 0.18 / 0.36	- / 0.18 / 0.36	- / 0.18 / 0.36	- / 0.18 / 0.36
Length with front crossover conveyor [m]	7.01	7.40	7.76	8.13
Length with rear crossover conveyor [m]	6.61	6.98	7.27	7.55
Discharge height, crossover conveyor [m]	0.79	0.81	0.81	1.03
Distance Centre of drawbar lug - Centre of axle [m]	4.37	4.55	4.55	4.70
Distance Centre of drawbar lug - Centre of axle with front crossover conveyor [m]	5.03	5.24	5.24	5.40
Dead weight				
with two-sided discharge [kg]	5,300 / 5,350 / 5,400	5,900 / 5,950 / 6,000	7,100 / 7,150 / 7,200	9,400 / 9,500 / 9,600
with crossover conveyor [kg]	5,500 / 5,550 / 5,600	6,100 / 6,150 / 6,200	7,300 / 7,350 / 7,400	9,600 / 9,700 / 9,800
Gross vehicle weight rating				
Admissible tongue load [kg]	1,800	1,800	1,800	2,000
Admissible tongue load if axle moved forward by 400 mm [kg]	400	-	-	-
Technically admissible gross vehicle weight rating 15 km/h, single axle [kg]	11,800	12,600	12,600	-
Technically admissible gross vehicle weight rating 15 km/h, tandem axle [kg]	-	11,800 (track 1650mm) / 17,800 (track 1720mm)	17,800 (track 1720mm) / 25,800 (track 1930mm)	18,000 (track 1720mm) / 26,000 (track 1930mm)
Gross vehicle weight rating 25 km/h (StV-ZO), single axle [kg]	11,800	11,800	11,800	-
Gross vehicle weight rating 25 km/h (StV-ZO), tandem axle [kg]	-	17,800 (track 1720mm)	17,800	18,000
Power required HP				
with switchgear 12.8/23 rpm	-	-	-	101 / 106 / 112
without switchgear 26 rpm	84 / 92 / 102	90 / 99 / 109	130 / 139 / 146	-
with switchgear 14.4/26 rpm	52 / 57 / 62	54 / 61 / 67	82 / 87 / 91	-
without switchgear 30 rpm	99 / 109 / 120	114 / 124 / 133	142 / 155 / 166	-
with switchgear 16.7/30 rpm	62 / 67 / 73	71 / 76 / 82	99 / 106 / 111	113 / 125 / 133
Power required kW				
with switchgear 12.8/23 rpm	-	-	-	75 / 78 / 83
without switchgear 26 rpm	61 / 67 / 75	66 / 72 / 80	95 / 102 / 107	-
with switchgear 14.4/26 rpm	38 / 42 / 45	39 / 44 / 49	60 / 64 / 67	-
without switchgear 30 rpm	72 / 80 / 88	83 / 91 / 97	104 / 114 / 122	-
with switchgear 16.7/30 rpm	45 / 49 / 53	52 / 55 / 60	72 / 78 / 81	83 / 91 / 97

Technical modifications reserved

Technical data Verti-Mix

Technical data Verti-Mix Double



	Verti-Mix 1501 Double 12 / 13.5 / 15 [m³]	Verti-Mix 1801 Double 14 / 16 / 18 [m³]	Verti-Mix 2401 Double 19 / 21.5 / 24 [m³]	Verti-Mix 3101 Double 25 / 28 / 31 [m³]
Axle				
Track width [mm]	1,520	1,520 / 1,650 / 1,720	1,720 / 1,930	1,720 / 1,930
Container				
Container wall thickness [mm]	8	8	8	8
Bottom plate [mm]	18	20	20	20
Container length inner dimension incl. overflow ring [m]	4.40	4.77	5.19	5.67
Vehicle height depending on tyres with single axle				
400/60-15.5 (18 PR) [m]	2.44 / 2.62 / 2.80	-	-	-
400/60-15.5 (18 PR) track 1500 mm, central axle position [m]	2.38 / 2.56 / 2.74			
8.15-15 (14 PR) double, track 1500 mm [m]	2.29 / 2.47 / 2.65	2.34 / 2.52 / 2.70		
8.15-15 (14 PR) double, track 1500 mm, central axle position [m]	2.28 / 2.46 / 2.64			
215/75 R 17.5 (133) double, track 1500 mm, central axle position [m]	2.35 / 2.52 / 2.70			
215/75R17.5 (133) double [m]	2.36 / 2.54 / 2.72	2.37 / 2.55 / 2.73		
235/75R 17.5, double, track 1720 mm [m]			2.68 / 2.86 / 3.04	
435/50 R 19.5 [m]	2.51 / 2.69 / 2.87	2.52 / 2.70 / 2.88	2.80 / 2.98 / 3.16	
435/50 R 19.5 track 1500 mm, central axle position [m]	2.49 / 2.67 / 2.85			
455/45R 22.5, track 1720 mm [m]			2.85 / 3.03 / 3.21	
Vehicle height depending on tyres with tandem axle				
10.0/75-15.3 TD track 1650 mm [m]	2.38 / 2.56 / 2.74			
400/60-15.5 (18 PR), track 1720 mm [m]	2.51 / 2.69 / 2.87	2.80 / 2.98 / 3.16		
435/50 R 19.5, track 1930 mm [m]		2.89 / 3.07 / 3.25	3.23 / 3.41 / 3.59	
435/50 R 19.5 TD, track 1720 mm [m]	2.58 / 2.76 / 2.94	2.86 / 3.04 / 3.22	3.23 / 3.41 / 3.59	

Technical data Verti-Mix Double



	Verti-Mix 3451 Triple 28.5 / 31.5 / 34.5 [m³]	Verti-Mix 4501 Triple 38.0 / 41.5 / 45.0 [m³]
Dimensions		
Length [m]	9.43	9.94
Width with crossover conveyor [m]	2.28	2.42
Width with one-sided discharge [m]	2.38	2.52
Width with two-sided discharge [m]	2.48	2.62
Outside wheel width [m]	2.17	2.36
Extension height [m]	- / 0.18 / 0.36	- / 0.18 / 0.36
Length with front crossover conveyor [m]	10.15	10.66
Discharge height [m]	1.10	1.05
Distance Centre of drawbar lug - Centre of axle [m]	5.86	6.00
Distance Centre of drawbar lug - Centre of axle with front crossover conveyor [m]	6.59	6.72
Dead weight		
with two-sided discharge [kg]	10,874 / 10,987 / 11,100	13,258 / 13,379 / 13,500
with crossover conveyor [kg]	11,174 / 11,287 / 11,400	13,558 / 13,679 / 13,800
Gross vehicle weight rating		
Admissible tongue load [kg]	2,000	2,000
Axle load [kg]	9,000	8,000
Technically admissible gross vehicle weight rating 15 km/h, tandem axle [kg]	26,000	-
Technically admissible gross vehicle weight rating 15 km/h, tridem axle [kg]	38,000	38,000
Gross vehicle weight rating 25 km/h (StVZO), tandem axle [kg]	20,000	-
Gross vehicle weight rating 25 km/h (StVZO), tridem axle [kg]	26,000	26,000
Power required HP		
with switchgear 12.8/23 rpm	-	170 / 180 / 190
with switchgear 14.4/26 rpm	140 / 150 / 160	-
with switchgear 16.7/30 rpm	160 / 170 / 180	-
Power required kW		
with switchgear 12.8/23 rpm	-	125 / 132 / 139
with switchgear 14.4/26 rpm	103 / 110 / 117	-
with switchgear 16.7/30 rpm	117 / 125 / 132	-
Axle		
Track width [mm]	1,730	1,800
Wheelbase [m]	1,360	1,360
Container		
Container wall thickness [mm]	8	8
Bottom plate [mm]	20	20
Container length inner dimension incl. overflow ring [m]	7.48	8.09
Vehicle height depending on tyres with tandem axle		
435/50 R 19.5, track 1930 mm [m]	2.90 / 3.08 / 3.26	-
235/75 R 17.5 double [m]	2.78 / 2.96 / 3.14	-
455/45 R 22.5 [m]	2.96 / 3.14 / 3.32	-
Vehicle height depending on tyres with tridem axle		
235/75 R 17.5 double, track 1720 mm [m]	2.78 / 2.96 / 3.14	3.12 / 3.30 / 3.48
435/50 R 19.5 [m]	2.90 / 3.08 / 3.26	3.20 / 3.80 / 3.56
455/45 R 22.5, track 1720 mm [m]	2.96 / 3.14 / 3.32	3.26 / 3.44 / 3.62

Technical data Verti-Mix Triple



www.strautmann.com

B. Strautmann & Söhne GmbH u. Co. KG



Bielefelder Straße 53
D-49196 Bad Laer
Phone: +49(0)5424/802-0
info@strautmann.com
www.strautmann.com